

**FOR INFORMATION ONLY:
DO NOT MANUFACTURE
PARTS TO THIS DRAWING**

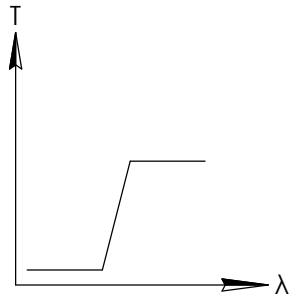
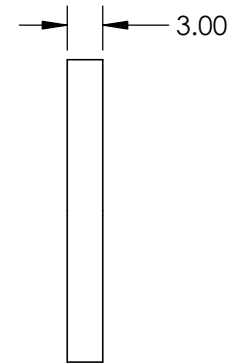
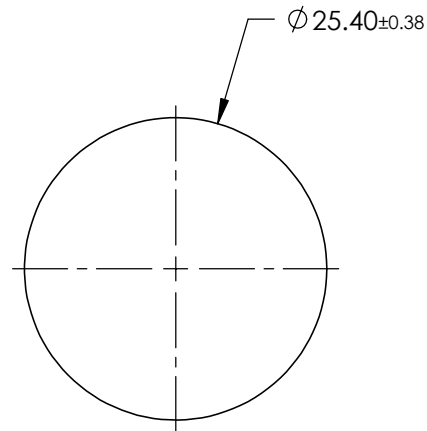
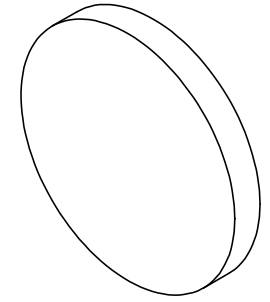

LONGPASS FILTER

SPECIFICATIONS SUBJECT TO CHANGE WITHOUT NOTICE
DIMENSIONS ARE FOR REFERENCE ONLY

REV. A	VALUE
SHAPE	PLANO
SPECTRAL TRANSMITTANCE $\pm_{ip}(\%)$	94
PASSBAND LIMIT λ_{p1} (nm)	710
CUT-OFF POSITION λ_c (nm)	630 \pm 6
STOPBAND LIMIT λ_s (nm)	540
WAVELENGTH	VIS
BEVEL	PROTECTIVE AS NEEDED



THIRD ANGLE
PROJECTION

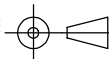

TITLE

$\varnothing 25.4\text{mm}$, RG-630 LONGPASS FILTER

ALL DIMS IN

mm

DWG NO

32755

SHEET
1 OF 1