

NOTES:

1. SUBSTRATE:
FUSED SILICA MOUNTED IN BLACK ANODIZED ALUMINUM RING
2. TRANSMITTED WAVEFRONT ERROR: $\lambda/4$
3. RoHS: COMPLIANT

FOR INFORMATION ONLY:
DO NOT MANUFACTURE
PARTS TO THIS DRAWING

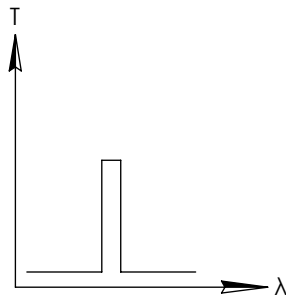
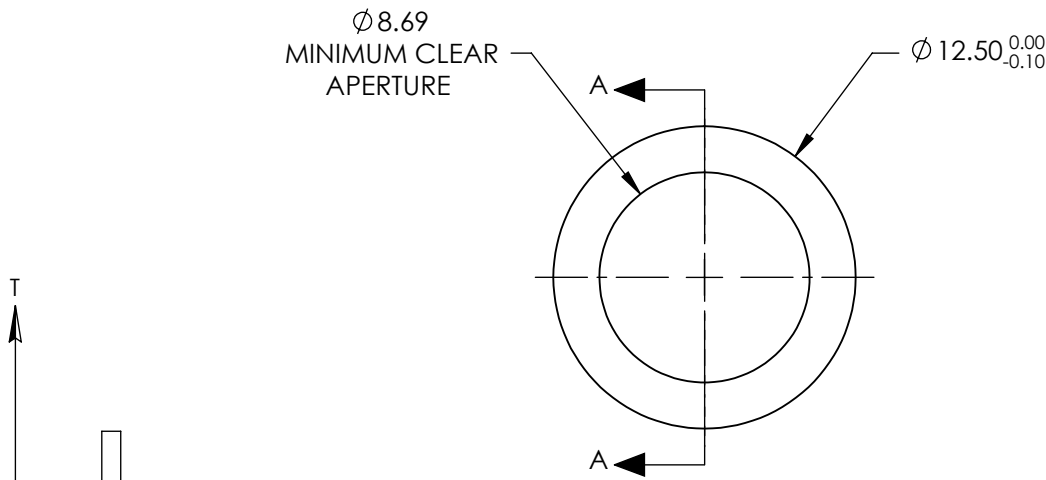

BANDPASS FILTER

SECTION A-A

	VALUE
CENTER WAVELENGTH (CWL) (nm)	585 ± 2
MINIMUM BANDPATH (nm)	36
FULL WIDTH HALF MAX (FWHM) (nm)	40
MINIMUM TRANSMISSION (%)	>93
OD6 BLOCKING RANGE (nm)	300 - 556 & 618 - 780
SURFACE QUALITY	60-40
COATING TYPE	HARD COATED
DURABILITY	MIL-C-48497A, SECT. 3.4.1
ENVIRONMENTAL	MIL-STD-801F, SECT. 507 .4

SPECIFICATIONS SUBJECT TO CHANGE WITHOUT NOTICE
DIMENSIONS ARE FOR REFERENCE ONLY

 **Edmund Optics®**

THIRD ANGLE PROJECTION 

TITLE OD6, Ø12.5mm, 585nm x 36nm, BP
FLUORESCENCE FILTER

ALL DIMS IN

mm

DWG NO

33906

SHEET
1 OF 1