

NOTES:

1. SUBSTRATE:  
CRYSTAL QUARTZ
2. COATING (APPLY ACROSS CLEAR APERTURE)  
S1 & S2: R(ABS) <0.25% @ 800nm  
DAMAGE THRESHOLD: 3.5 J/cm<sup>2</sup> @ 10ns @ 1064nm
3. SURFACE S1 TO BE PARALLEL TO SURFACE S2 TO WITHIN <0.5 arcsec
4. RETARDANCE:  $\lambda/2 \pm \lambda/200$
5. TRANSMITTED WAVEFRONT:  $\lambda/10$  FOR CENTRAL 80% OF CLEAR APERTURE
6. RoHS COMPLIANT

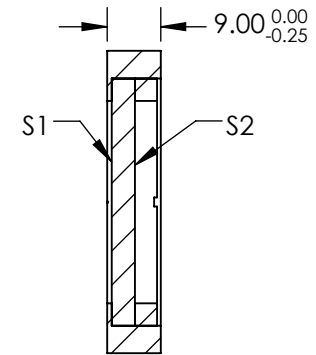
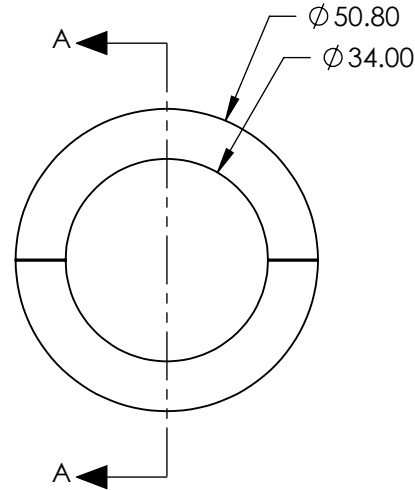
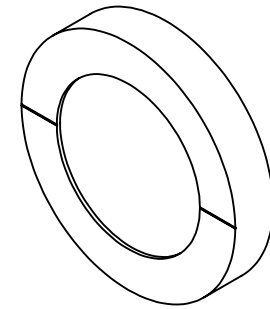
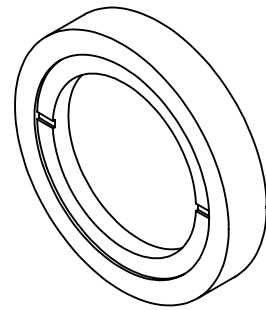

SECTION A-A

**FOR INFORMATION ONLY:  
DO NOT MANUFACTURE  
PARTS TO THIS DRAWING**

SPECIFICATIONS SUBJECT TO CHANGE WITHOUT NOTICE  
DIMENSIONS ARE FOR REFERENCE ONLY

**EO**® Edmund Optics®

	S1	S2	THIRD ANGLE PROJECTION		TITLE	50.8mm DIA. 800nm $\lambda/2$ QUARTZ WAVEPLATE ZERO ORDER	
CLEAR APERTURE	Ø34.0	Ø34.0	ALL DIMS IN	mm	DWG NO	85055	SHEET 1 OF 1
SURFACE QUALITY	10-5	10-5					