

NOTES:

1. SUBSTRATE:
Crystalline Quartz
2. COATING (APPLY ACROSS COATING APERTURE):
S1 & S2: R(AVG) <0.5%
- DAMAGE THRESHOLD,
PULSED: >20 J/cm², 10ns @ 10Hz @ 1064nm
3. SURFACE S1 TO BE PARALLEL TO SURFACE S2 TO WITHIN <3 ARCSEC
4. RETARDANCE: $\lambda/2 \pm \lambda/100$ @ 20°C
RETARDANCE ORDER: 1st
5. DESIGN WAVELENGTH: 266nm
6. TRANSMITTED WAVEFRONT: < $\lambda/10$ @ 632.8nm
7. ROHS: COMPLIANT

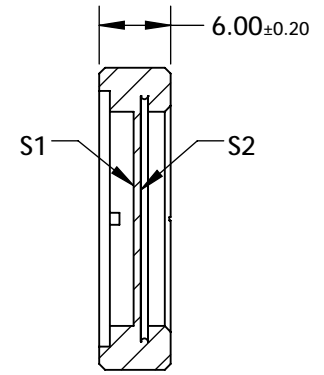
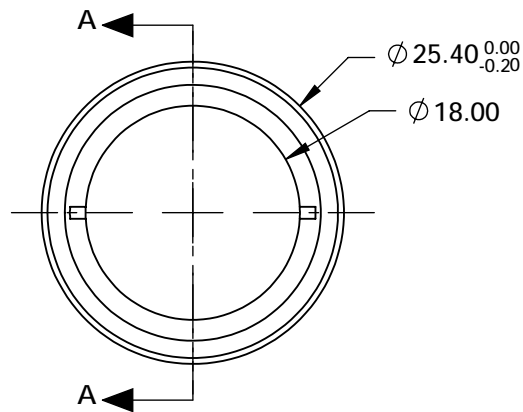

SECTION A-A

**FOR INFORMATION ONLY:
DO NOT MANUFACTURE
PARTS TO THIS DRAWING**

SPECIFICATIONS SUBJECT TO CHANGE WITHOUT NOTICE
DIMENSIONS ARE FOR REFERENCE ONLY

EO® Edmund Optics®

	S1	S2	THIRD ANGLE PROJECTION	TITLE	25.4mm Dia., 266nm, $\lambda/2$ High Energy Waveplate	
SURFACE QUALITY	20-10	20-10	ALL DIMS IN	mm	DWG NO	39161
CLEAR APERTURE	Ø18.00	Ø18.00				SHEET 1 OF 1